

LEAN MANUFACTURING IMPLEMENTATION FOR NEW PRODUCT DEVELOPMENT EFFECTIVENESS: CASE STUDY ON THE INDUSTRY OF WIRE STEEL AND DERIVATIVES

by Muharom Muharom

Submission date: 05-Oct-2021 10:21AM (UTC+0700)

Submission ID: 1665599231

File name: ESS_CASE_STUDY_ON_THE_INDUSTRY_OF_WIRE_STEEL_AND_DERIVATIVES.pdf (666.48K)

Word count: 6611

Character count: 35344

APPLICATION OF NEW PRODUCT DEVELOPMENT VALUE STREAM MAPPING: CASE STUDY ON WIRE STEEL AND NAILS INDUSTRY

Muharom^{1*)}, M. Hasan Abdullah²⁾, Imam Kholik³⁾

Mechanical Engineering, Wijaya Putra University, Jl. Raya Benowo 1-3, Surabaya 60197, Indonesia^{1),3)}
Industrial Engineering, Wijaya Putra University, Jl. Raya Benowo 1-3, Surabaya 60197, Indonesia²⁾

Abstract This study provides experience in applying VSM to the product development process. This research was conducted in a wire and nail industry in Indonesia. The company develops products that have never been made before. During the product development process, the organization does not identify in detail the potential for waste at each stage of product development. This is reinforced by the results of the questionnaire distributed to employees at all levels. So, the process of developing new products becomes less efficient. The application of lean concepts to the product development process will help identify potential waste that exists. The results showed the existence of Non-Value-Added (NVA) activities at the concept development stage, the testing & refinement stage, design details, system level design and planning. The application of product development value stream mapping can identify VA (Value Added) of 53% and NVA 47%. There is potential to shorten time to market by 18% or 47 days. From the initial 262 days to 215 days.

Keywords: New product development, lean manufacturing, Value Stream Mapping

1. Introduction

PT. SW, a wire and nail factory, seeks to innovate through the development of new products. Product development is carried out through several stages and involves several departments. Product development starts from exploring ideas. The customer needs survey is carried out at the planning stage. After that proceed to the concept development stage, the system level design stage, the detailed design stage, the testing and refinement stage, then to the production ramp-up stage [1]. In the process of developing this product, the organization does not identify in detail about waste at each stage. So the development time becomes less effective. Using lean concepts in the product development process will help in identifying existing waste potential.

Lean concept is an approach to eliminate waste in production, increase the added value of a product and provide value to customers which is done continuously. In the product development process found some waste. Among others; waiting, transportation, movement, unnecessary processes, stock, overproduction, defects, reinvention, lack of discipline in the process and

on the value of creation and how to prevent limited information technology resources. Lean's thinking illustrates how to focus attention waste as a main principle. The aim is to systematically transfer the principles of lean thinking into the implementation of product development. Moreover, lean concept can be apply into maintenance area such as in the Sugar Factory to minimize the downtime with developing MVSM [2].

The organization has not identified the waste in product development that is carried out. Therefore, research is needed that can identify and eliminate waste so that it has an impact on increasing company productivity. This research is proposed to identify and eliminate waste that occurs in each phase of product development through the Product Development Value Stream Mapping (PDVSM) approach. With the introduction of the principles and application of lean product development, it is expected that the potential waste during the product development process can be known and controlled by the organization.

2. Literature Review

2.1. Innovation strategy

Organizations can carry out innovation strategies according to their abilities. Companies can do

* Corresponding author. Email : muharom@uwp.ac.id
Published online at <http://jemis.ab.ac.id>
Copyright © 2019 JTIUB Publishing. All Rights Reserved

Cite this Article As Muharom et al. (2019). Application Of New Product Development Value Stream Mapping: Case Study On Wire Steel And Nails Industry. *Journal of Engineering and Management in Industrial System*, 7(2), p53-68

Paper Accepted : November 28, 2019

Paper Published : November 30, 2019

four types, namely product innovation, process innovation, market innovation and organizational innovation [3]. Product innovation can be done through introducing new products or increasing the value of an item or service. Process innovation can be done by implementing a new process in production. Such as changes in the way, equipment and software. Market innovation can be done by changing product design (packaging), placement, promotion and price. While organizational innovation can be done through system changes in the organization, external / internal relations of the organization. This organizational innovation can reduce administrative costs, transaction and delivery costs, increase workplace satisfaction and workforce productivity [3]. Both product, process and market innovation can increase efficiency in companies [4].

Previous research shows that the application of several types of innovation has a positive impact on industry performance. Innovation strategies also affect organizational knowledge and performance [5]. Chandra and Haryadi (2016) conducted a product innovation study conducted in a plastic manufacturing industry that was able to increase revenue and demand by 15%. Process changes made by the company are more practical and quick to complete. Because these changes can eliminate unnecessary processes[6].

2.2. Lean manufacturing concepts

Lean manufacturing can be defined as a systemic approach to identifying and eliminating waste or activities that have no added value. Improvements are made continuously by flowing products (material, process, output) and information using a pull system from internal and external customers. This is done to pursue excellence and perfection in the manufacturing industry [7]. The type of waste in the manufacturing process can be identified as 7 or better known as seven waste [8]. Namely, waste transportation, inventory, motion, waiting, over production, over process and defects.

Implementation of lean manufacturing is proven to be able to improve industrial performance. Implementation of lean is able to identify and reduce leadtime processes in machine maintenance and production processes [9;10]. The application of lean manufacturing can increase production capacity[7]. Lean Thinking in innovation management cannot be applied
Cite this Article As Muharom et al. (2019). Application Of New Product Development Value Stream Mapping: Case Study On Wire Steel And Nails Industry. *Journal of Engineering and Management in Industrial System*, 7(2), p53-68
Paper Accepted : November 28, 2019
Paper Published : November 30, 2019

systematically and universally. For this reason, a Lean Innovation approach is needed and a focus on Value System [11]. This method is able to perform and manage value-oriented processes.

Lean product development is an approach to eliminating waste in the product development process. The main thing in Lean is to eliminate waste in all aspects of the product development process and related to production [12]. Five principles in implementing lean product development, namely: 1) clearly defining customer problems and identifying product-specific functions as answers to problems. 2) identify processes related to cost reduction and product quality improvement. 3) eliminate waste and unnecessary costs to produce an appropriate product. 4) continually interacting with customers to improve the process. 5) applying methods and ways to reduce costs to the business continuously [13].

3. Value stream mapping in product development

Value Stream Mapping (VSM) is a method in which lean principles are applied in examining business processes. VSM can be defined as the method used by managers and engineers to increase understanding of the company's development efforts. VSM can be an important tool for improving the Product Development (PD) process. The aerospace industry experience shows that both value stream mapping tools and lean context are correlated with the success of process improvement. No best practices were found. However, the lean terminology reviewed to be applied to PD, combined with several complementary value flow mapping methods, provides an effective set of tools for mapping PD value flow [14].

There are two value stream maps that must be created to design lean manufacturing in a company called the current-future value stream map. Current value stream map is a mapping based on the current conditions of the production process. It aims to identify waste and actual processes of production. So, it can be seen clearly the location of activities that do not provide added value to consumers. The basic principles of the current value stream map include: observing the process of making certain products or providing services, recording specific data (operations performed, inputs, outputs, performance indicators, work parameters, work organization, as well as other

information needed), and representations of all the results of these observations use certain graphic symbols [11].

Future value stream map is created based on the previously created value stream map. It aims to improve the parts of activities that have waste and do not give added value to consumers. Future value stream map helps companies create projects or new steps in the plan to change the company's production efficiency. This mapping will be the basis for every decision to improve the production process.

2.4. Research gap

This research was conducted to develop lean concepts in product development in an industry that exists in manufacturing nails and wires. Data obtained from interviews and questionnaires with Participants involved in the product development process. VSM is built at every stage in product development from planning to product launch. VSM serves to detect waste at the New Product Development stage. Waste at each stage will be displayed in detail and tested for validity. Only the waste that has the biggest weight will be searched for the cause and developed with the latest VSM model. In the end, the latest VSM with eliminated waste will be used as a reference for the process improvement needed for the organization.

3. Research Methodology

This research was conducted to implement the concept of lean product development in a product in a steel wire manufacturing company.

Step 1. Identification

This stage is the initial step undertaken with the aim of finding out the problem that is the object of research. This stage includes the formulation of the problem, the study of literature, the objectives and scope of the research. Problem identification is based on how to identify waste in the product development process with a lean product development approach. The research objective is to identify the waste that occurs in the process of developing new products. Literature studies include journals related to lean product development concepts and related book references. Field observations include observations of company conditions, both physical flow and information to identify waste.

Step 2. Collection and data processing

Data collection and processing stage is carried out by direct observation, interviews, and distributing questionnaires. The description of a company's condition by using Big Picture Mapping, which is a tool used to describe a system as a whole and the value stream associated with the product development process. The stages and elements of the research questionnaire were developed as in Table 1.

Interviews and distributing questionnaires were carried out on several parts involved in the product development process, namely the head of the Division (which oversees all departments), Marketing, Purchasing, Engineering, Production, and QA & QC. From the results of these data will be weighted to determine the priority of improvement at each stage of product development.

Table 1. Stages and questionnaire

Development stages (T) (Ulrich & Eppinger, 2001)	Type waste (W) (Ohno, T. 1988)	Identifikasi waste Question (Q) (McManus, 2005)
Planning (T1)	W1 (waiting)	Q1
	W2 (inventory)	Q2
	W3 (excessive processing)	Q3
	W4 (over production)	Q4
	W5 (transportation)	Q5
	W6 (unnecessary motion)	Q6
	W7 (defects)	Q7
Concept development (T2)	W1 - W7	Q8 - Q14
System level design (T3)	W1 - W7	Q15 - Q21
Detail design (T4)	W1 - W7	Q22 - Q28
Testing & refinement (T5)	W1 - W7	Q29 - Q35
Production ramp-up (T6)	W1 - W7	Q36 - Q42

Cite this Article As Muharom et al. (2019). Application Of New Product Development Value Stream Mapping: Case Study On Wire Steel And Nails Industry. *Journal of Engineering and Management in Industrial System*, 7(2), p53-68

Paper Accepted : November 28, 2019

Paper Published : November 30, 2019

Step 3. Improvement process and conclusion

At this stage the process improvement formulation is carried out to minimize waste in each phase of product development. The proposed improvement is based on the results of data processing and analysis in the previous stage. Each phase of product development will identify the waste that occurs and a weighting is done to determine the most dominant waste. Through Root cause analysis (RCA), the root cause of the problem will be searched to find the cause and process improvement in the future.

4. Result

4.1. New product development process

This section will present information about the stages of product development, structure and initial conditions in the company. The following description of the company's product development process results from observations and interviews during the study.

– Product development stage

In planning and developing new products, the company adopts the stages of what Ulrich and Eppinger (2001) have revealed [1]. Planning is done in advance with consideration of the need for new product development. This idea arose based on the results of the initial survey and suggestions of the Directors through a management review meeting. Furthermore, the agreed planning will proceed to the next stage, namely the development of concepts, the level of the design system, the design details, the testing and improvement stages and then to the final stage, namely the initial production. Each stage will be reviewed and validated by the Board of Directors and the Development Team Leader. Following the flow of planning and developing new products in a company.

From the product development stage, the researcher will analyze the development of new products with the concept of Lean or lean new product development (LNPD).

By using Value Stream Mapping (VSM) on this

lean concept, it can be known activities that have added value or value added, activities that do not have added value or non-value added (NVA), as well as activities that do not need or can be eliminated (waste) during product development finished.

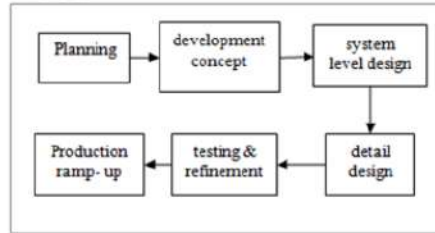

Figure1. Product development stage

– Organizational structure of product development.

The product development process is an activity carried out by several sections in the organization. Therefore, the organization makes a structure in relation to the planning and product development that will be carried out. The product development team is drawn from several personnel in the Marketing, PPIC, RND and Engineering sectors as needed in product development. Furthermore, a Project Proposal will be made by the Development Team and will be submitted by the Directors for approval.

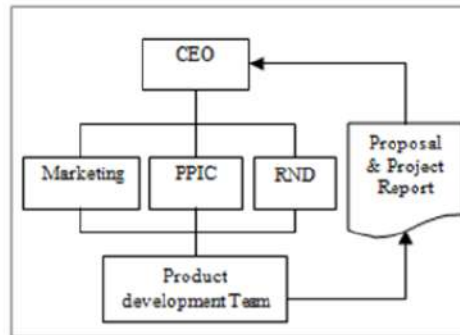

Figure 2. Product Development Organization

Cite this Article As Muharom et al. (2019). Application Of New Product Development Value Stream Mapping: Case Study On Wire Steel And Nails Industry. *Journal of Engineering and Management in Industrial System*, 7(2), p53-68
 Paper Accepted : November 28, 2019
 Paper Published : November 30, 2019

Table 2. The result of lean concepts

No.	Question	Average	Weight	Correlation value (r counted)	value r table ($\alpha=5\%$, $n=16$)
1	Does the company do new product development (NPD) as a part of business?	3.938	0.150	0.613	0.497 valid
2	Is NPD process done with stages start from development concept until the beginning production?	4.063	0.155	0.534	valid
3	Does the company choose NPD team in every new product development?	3.063	0.117	0.685	valid
4	Does NPD team follow in every stages/ process in the new product development?	3.438	0.131	0.824	valid
5	Do every member of NPD team understand well about the contribution of new development product effectivity?	3.125	0.119	0.593	valid
6	Does the organization use value stream mapping (VSM) in new product development?	2.125	0.081	0.273	invalid
7	Does the organization do the repair for waste that found in the new product development?	3.375	0.129	0.642	valid
8	Does the new product got add value for the company?	3.063	0.117	0.550	valid

*scale 1 to 5 is used for measurement of the respondent: 1=never, 2=rarely, 3=seldom, 4=often, 5=always.

– Lean implementation company measurement results.

To find out how organizations apply lean concepts, an initial survey is needed. This survey was conducted to see the gap in the application of lean product development in organizations. Participants taken in this survey are those who have experience and are involved on product development namely at employees with middle to upper level.

From the results of the questionnaire it appears that in general the organization has been developing new products quite consistently (value 3 or more). The stages of development are carried out through stages according to the rules as stated by Ulrich and Eppinger (2001), the process of developing new products is carried out by following the stages from planning, concept development to initial production [1].

Organization has not conducted an analysis related to the waste that occurs during the development process. It appears that Value Stream Mapping has not been used in the process of developing new products (value less than 3). Validity was not fulfilled for the statement of the use of VSM in the development of new products. To analyze the the VSM need to measuring the standard time considering the allowance and the performance rating [15].

4.2. Waste identification in all product development Stages

Cite this Article As Muharom et al. (2019). Application Of New Product Development Value Stream Mapping: Case Study On Wire Steel And Nails Industry. *Journal of Engineering and Management in Industrial System*, 7(2), p53-68
Paper Accepted : November 28, 2019
Paper Published : November 30, 2019

This section will provide an overview of Value Stream Mapping in the process of product planning and development. Each activity will know the processing time and waiting time. Each activity can be categorized into Value Added and Non-Value Added as well as activities that can be eliminated or waste. In general, the initial VSM description is at Figure 3.

The waste identification results above can be concluded in the form of waste identification tables and their weighting scores. Each development stage has a different type of waste. Scoring is done to make priorities in analyzing the causes and giving suggestions for improvement. Table 4 shows the types of waste and their identification at each stage of product development. The highest score is based on a questionnaire conducted on the respondent.

– Planning stage waste identification.

In the planning stage, excessive processing becomes the biggest waste. Reviews are repeated by the Directors or Division Heads of this activity. Any information and data related to the development of new products must be approved by top management before being used for further processing. The Planning phase begins with the decision of the management review results to develop new products. The idea of developing a new product is based on consumer needs and issues that arise that require the organization to develop new products. The following is an overview of VSM in the Planning stage.

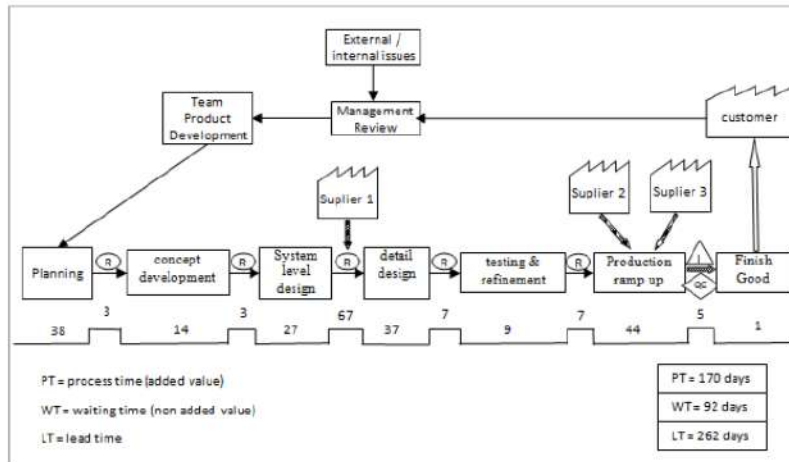

Figure 3. VSM current state product development

Table 3. The result of waste identification

New product development stage	Identification of waste	average scores	Rank
CONCEPT DEVELOPMENT	Lack of information about customer need for new product developed	4.00	1
TESTING & REFINEMENT	Lack of skill operator. Set up work repeatedly to meet specification.	3.88	2
DETAIL DESIGN	The production layout has not been properly applied	3.71	3
SYSTEM LEVEL DESIGN	Lack of design personal. Lead time design takes longer	3.56	4
PLANNING	Over review by top management.	3.49	5
PRODUCTION RAMP UP	some processes are worked by outsourcing	3.39	6

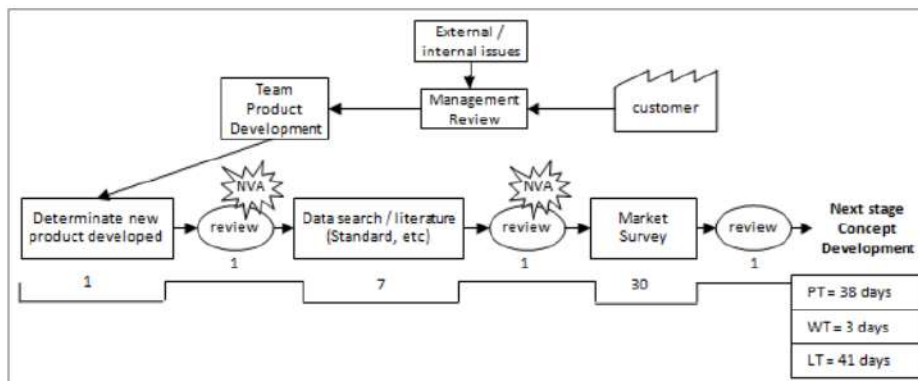

Figure 4. VSM Current state of planning

Cite this Article As Muharom et al. (2019). Application Of New Product Development Value Stream Mapping: Case Study On Wire Steel And Nails Industry. *Journal of Engineering and Management in Industrial System*, 7(2), p53-68
 Paper Accepted : November 28, 2019
 Paper Published : November 30, 2019

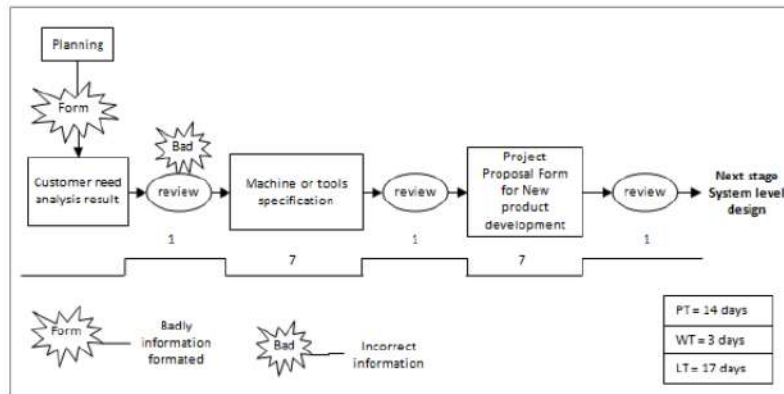

Figure 5. VSM Current state of concept development

The idea of developing new products that emerged then continued with the search for literature and other supporting information, including a survey of the needs of the product to be developed. The time needed at this stage is 41 days divided into processing time (PT) or 38 days value added and waiting time (WT) or Non value added for 3 days. This non-value added (NVA) needs to be reduced.

– Concept development stage waste identification

At this stage there is a waste where customer information needs related to the product to be developed are incomplete or not sufficiently represented. This will complicate the development team in determining the appropriate specifications and the possibility of a gap between the design and customer perception.

Observation results indicate that the Development Team lacks sufficient information about or there is a lack of information regarding customer needs. The team does not yet have a method and planning and focus on the product to be developed. As a result, information is absorbed less so that the product concept has not been formed properly. Waste that occurs is shown in the VSM at figure 5. Survey form planning, market segmentation and focus on product mission need to be done so that the product concept to be developed is in line with customer expectations. The time needed at this stage is 14 days for added value and 3 days for non-added value, so the lead time needed is 17 days.

– System Level Design waste identification

This stage is the implementation of the approved project proposal. At this stage the initial product concept design can change according to the development of information obtained. This change is in accordance with the Standards or specifications requested on the product. Many demand for design drawings of products, machinery and equipment needed. So we need personnel who have the ability to do it. Here the organization has limited personnel so that the work time becomes longer. Not all Development Team members master drawing techniques. In addition, waste of waiting time also occurs in the procurement of machinery or machinery because it must be imported.

The results of the questionnaire showed that the time wastage that occurred had the highest average score of 3.56. This shows that waiting type waste is almost common and becomes a major obstacle at the system level design stage. In the following VSM it can be seen that the process of product architecture drawing takes 20 days and the lead time for the machine procurement is 60 days. Added value at this stage is 67 days and non-added value is 27 days. Limitations of drawing personnel and computer CAD will affect the time in completing tasks related to product design.

– Detail design stage waste identification

At this stage, machinery and equipment components that have been purchased or ordered are installed. Planning the layout of the machine initially did not pay attention to the order of the process so that the engine layout became

Cite this Article As Muharom et al. (2019). Application Of New Product Development Value Stream Mapping: Case Study On Wire Steel And Nails Industry. *Journal of Engineering and Management in Industrial System*, 7(2), p53-68
Paper Accepted : November 28, 2019
Paper Published : November 30, 2019

ineffective. Layout planning does not pay attention to calculation of handling or transportation costs, only utilizes the available space. The design of the machine foundation is not in accordance with the existing conditions so it must be repositioned. The main waste at this stage is an ineffective layout design so that when the production process is running, additional transportation is needed for material transfer. Besides machines or equipment that are purchased (imported) are not accompanied by clear instructions regarding the design of the foundation or its assembly. This can complicate the development team. The time needed for this stage is 30 days. This time is needed to make detailed drawings and the construction of the machine foundation until it is ready for use. NVA occurs due to repositioning or changes in engine foundation due to incompatible specifications with the actual conditions. Next is the initial

VSM at the detailed design stage. The total lead time needed is 44 days.

– Testing & Refinement waste identification

The testing and repair phase is the final stage before the initial production is carried out. This stage is at once to do a trial on a machine or equipment that has been installed. At this stage the product development team is repeatedly setup and trial machines and repairs until the product is produced according to the expected specifications. The biggest waste at this stage is testing and improving machine settings. The results of the questionnaire showed an average level of 3.88 scores.

The time needed in the testing and repair phase is 16 days. Testing and repairing new machines takes 14 days to meet the criteria according to specifications. The following VSM results of research at the testing and refinement stage.

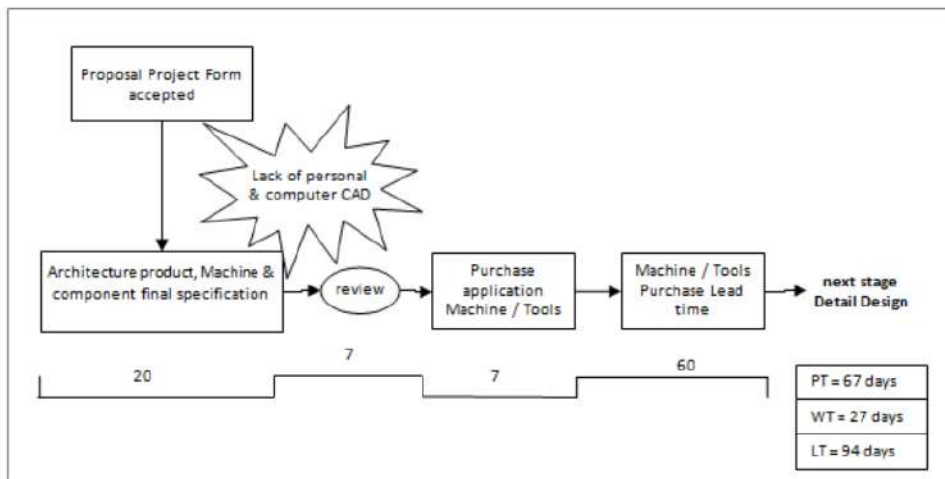

Figure 6. VSM Current state of system level design

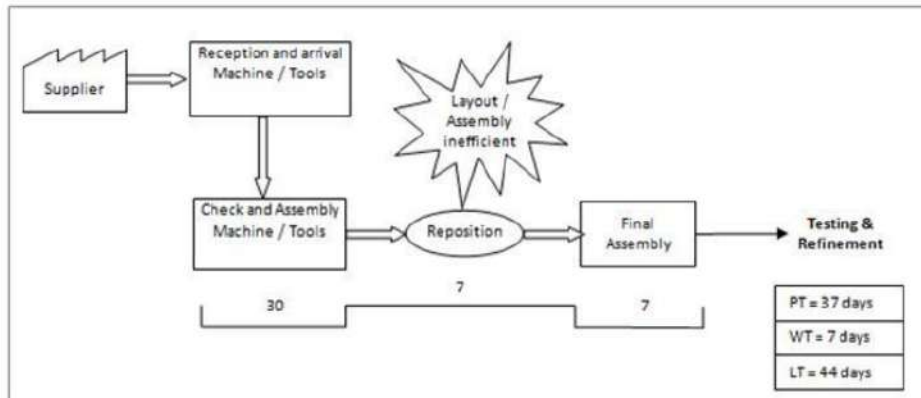

Figure 7. VSM Current state detail design stage

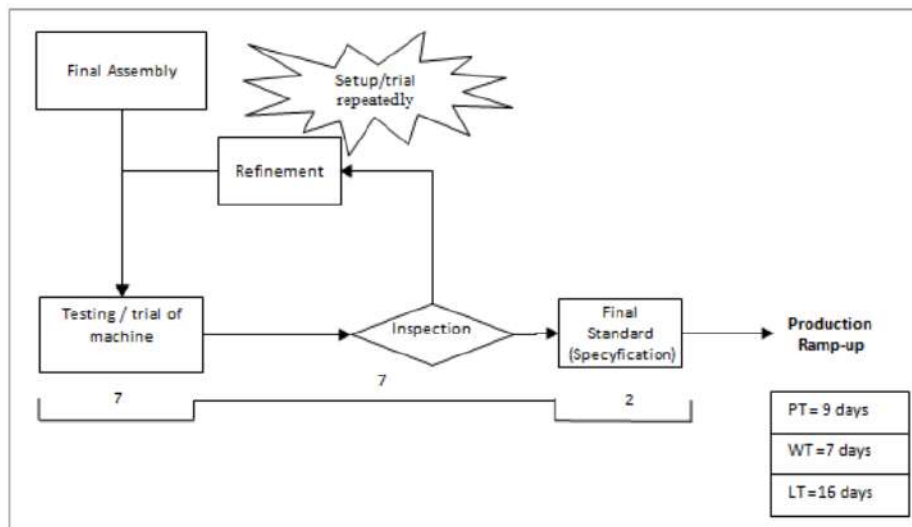

Figure 8. VSM Current state of Testing & Refinement

– The Production Ramp-Up waste identification

This stage is the final stage of product development. After testing and repairing the engine, the initial production will be carried out at the capacity planned by PPIC. Final product specifications and process procedures are made as standard in production. In the production process there are several processes that are still carried out by outsiders (outsourcing). The

hardening and coating process is still done by two different suppliers so that the lead time is longer. The results of identification of waste in the initial production phase indicate that outsourcing is still an option to complete the process that has not been able to be done by the company itself. From existing suppliers, the hardening process is still carried out outside the area so it requires a long transportation time.

From the current VSM image, it can be seen the

Cite this Article As Muharom et al. (2019). Application Of New Product Development Value Stream Mapping: Case Study On Wire Steel And Nails Industry. *Journal of Engineering and Management in Industrial System*, 7(2), p53-68

Paper Accepted : November 28, 2019

Paper Published : November 30, 2019

time needed to process 1 Ton of Product from start to finish takes 50 days. Process 1 and process 2 are still being outsourced, each requiring a 10-day process. Whereas preparation of material and process 1 takes 7 and 12 days.

4.3. Causes analysis of Waste and Refinement

In this section, the waste that has been identified at each stage of product development will be analyzed the main causes for improvement in the future process.

- Waste Analysis in planning stage

In the planning stage, excessive processing is an over review of several stages by the Directors and Division Heads. The initial review carried out after the product development literature became unrepresentative because it had not been supported by survey results related to new products. Reviews are more effective when product missions, literature and supporting surveys are complete. This is to avoid lack of information on the product to be developed. The review is only done once so it will shorten the time from 41 days to 38 days.

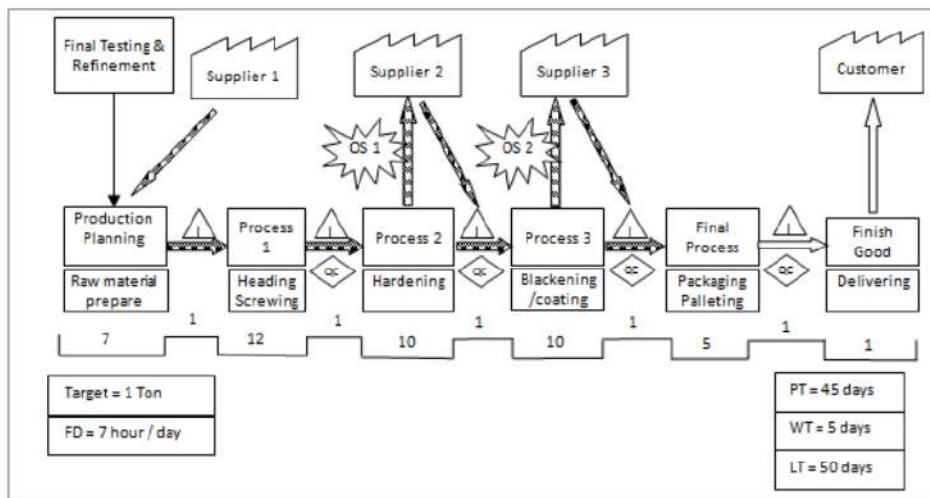

Figure 9. VSM Current state production ramp-up stage

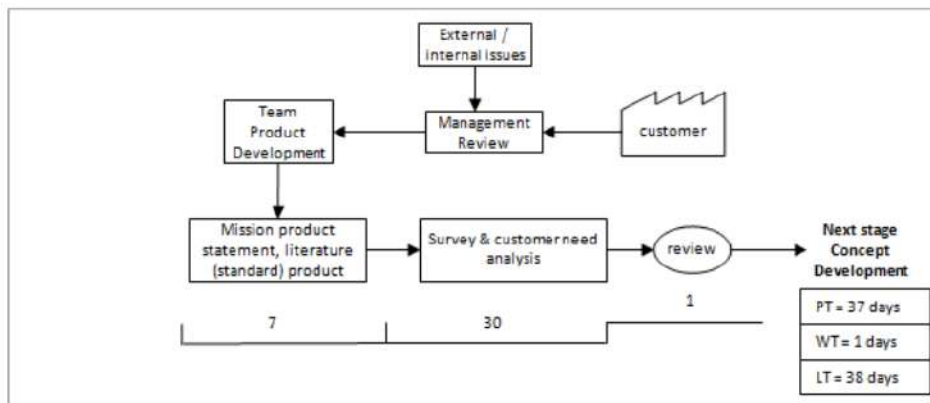

Figure 10. VSM future state of planning

Cite this Article As Muharom et al. (2019). Application Of New Product Development Value Stream Mapping: Case Study On Wire Steel And Nails Industry. *Journal of Engineering and Management in Industrial System*, 7(2), p53-68

Paper Accepted : November 28, 2019

Paper Published : November 30, 2019

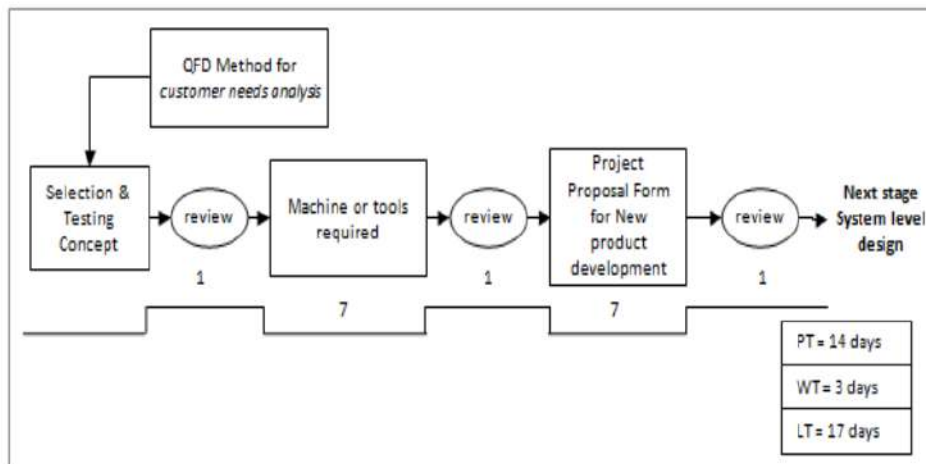

Figure 11. VSM future state of concept development

– Waste analysis in concept development stage

At this stage the type of waste that arises is the lack of information or customer needs that are not representative. This is because at the planning stage, surveys of customer needs for products to be made have not been done well. So that a re-survey is needed.

Some methods for analyzing customer needs such as Quality Function Deployment (QFD) or others can be used. By knowing the customer's desire for the product, the product concept will be easy to develop. Unsuitable questionnaire models and product misinformation can be avoided.

– Waste analysis in The system level design

At this stage constraints occur in the design of obstructed product architecture images. Because personnel who have limited technical drawing skills. So the time needed is longer. Proposed improvement can be done by providing technical drawing training with computer equipment or CAD for the development team. Thus the drawing design process does not depend on just one person. This training is expected to shorten the time in designing product images and other supporting equipment drawings from 20 days to 7 days. For the procurement of production machinery, the organization still relies on imports. So the lead time needed is around 60 days. There is no adequate local machine product for the product development needed.

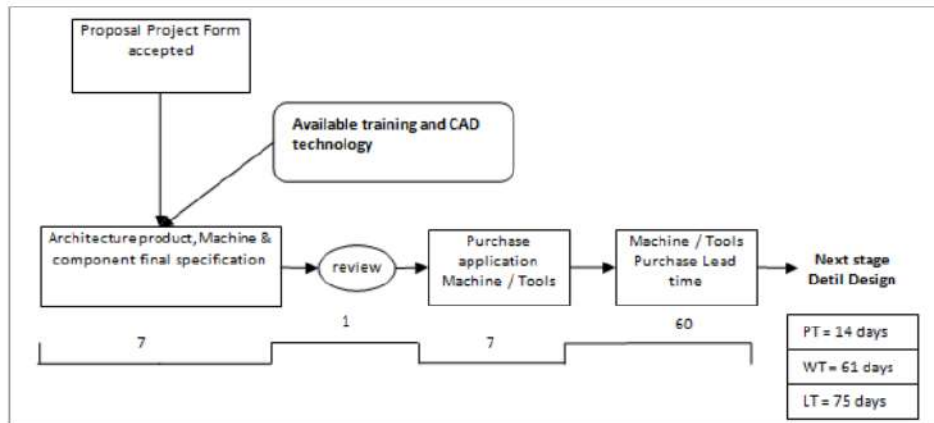

Figure 12. VSM future state for system level design

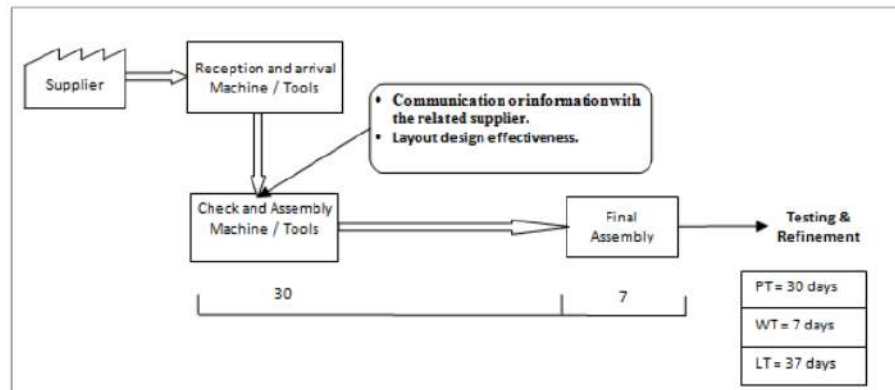

Figure 13. VSM future state detail design stage

– Waste analysis in stage of detailed design

At this stage, wastage occurs arising is happened because of wrong information about the drawing design with real one, there is no guide book, design Assembly or minimal information from the related supplier of machinery or equipment is purchased. Thus, it takes time to learn the process of assembling first and even repositioned layout that was made earlier. Then to reduce wastage, we need to the related information of the machine, the image layout, assembly and user manual should be completed at the moment of the purchase of the machine.

– Waste analysis in stage of testing & refinement

During the testing and refinement phase, the development team often had difficulty in setting

up the machine. This is because there is no initial training to set up the machine. The team only relied on manuals from the engine manufacturer and conducted their own trial. The guidebook is also not very detailed in providing instructions. So it takes more time to be able to set up to produce products according to specifications. This waste of time can be reduced by conducting training directly from the manufacturer's instructor where costs are included in the cost of procuring the machine. From the training, experiments and repairs can be made an operating standard in running the machine. Thus the machine operator will easily understand and run the machine and will reduce the frequency of testing and repairs. Here is the final VSM that can be achieved in the testing and refinement phase.

Cite this Article As Muharom et al. (2019). Application Of New Product Development Value Stream Mapping: Case Study On Wire Steel And Nails Industry. *Journal of Engineering and Management in Industrial System*, 7(2), p53-68

Paper Accepted : November 28, 2019

Paper Published : November 30, 2019

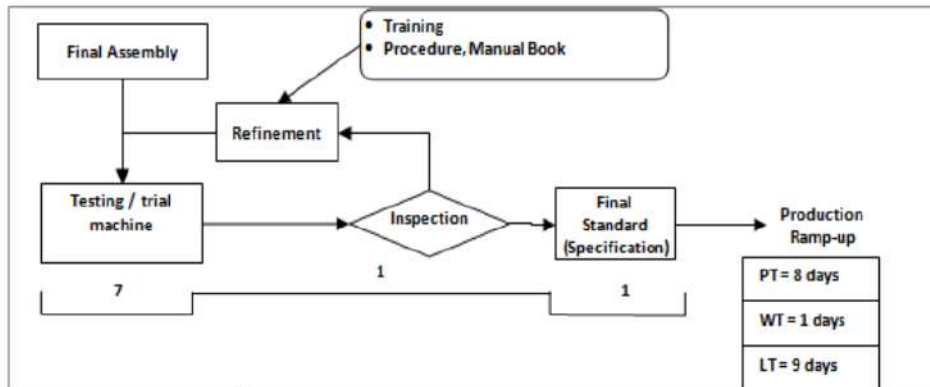

Figure 14. VSM future state of testing & refinement

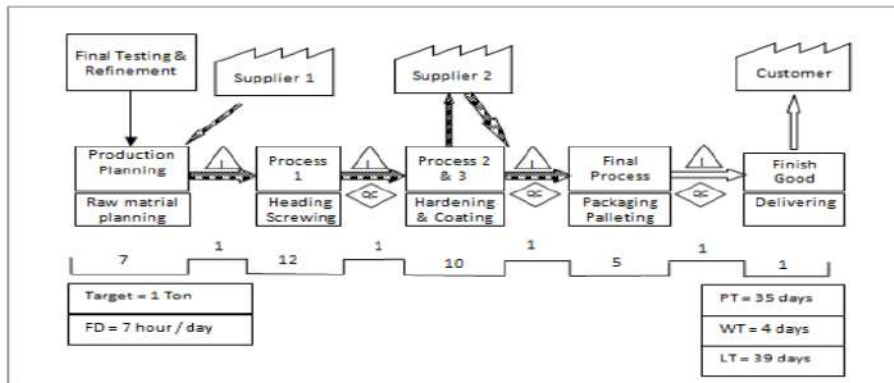

Figure 15. VSM future state production ramp-up stage

– Waste analysis in production ramp-up

In the final stages of the development of this new product, waste occurred in the production process still to be worked out (outsourcing). There are two processes that are still done outside and carried out by two different suppliers. This is causing lead time becomes longer. VSM results following improvement.

Process of hardening and coating (blackening) on making a Screw each takes 10 days to produce 1 ton of product. The fixed proposal is given to the process of combining these 2 into one place (supplier) only. Team developer is looking for a supplier that can make the process of hardening while blackening for Screw products developed. This will be saving half time.

4.4. Improvement results of lean product development value stream mapping

This section will present the results of achievements before and after improvements to the product development process. In table 5 it can be seen that in the initial condition (current state) the total time required from the initial stage to the final stage of product development (lead time) is 262 days. This time calculation is divided into two, namely value added (VA) and non value added (NVA). VA is calculated from the amount of process time (process time) at each stage of development. While the NVA is calculated time that is not involved in the process or waiting time (waiting time).

Lead time is the total time needed from start to finish or is the sum of VA and NVA. In the after-repair condition (future state) the total time is

Cite this Article As Muharom et al. (2019). Application Of New Product Development Value Stream Mapping: Case Study On Wire Steel And Nails Industry. *Journal of Engineering and Management in Industrial System*, 7(2), p53-68

Paper Accepted : November 28, 2019

Paper Published : November 30, 2019

reduced to 215 days. Some improvements have been made at each stage as discussed in the previous sub-chapter.

Table 4. Total lead time current state and future state

New Product Development Stage	Current State		Future State	
	VA	NVA	VA	NVA
Planning	38	3	37	1
Concept development	14	3	14	3
System level design	27	67	14	61
Detail Design	37	7	30	7
Testing & Refinement	9	7	8	1
Production Ramp-up	45	5	35	4
Total Lead Time (day)	262		215	

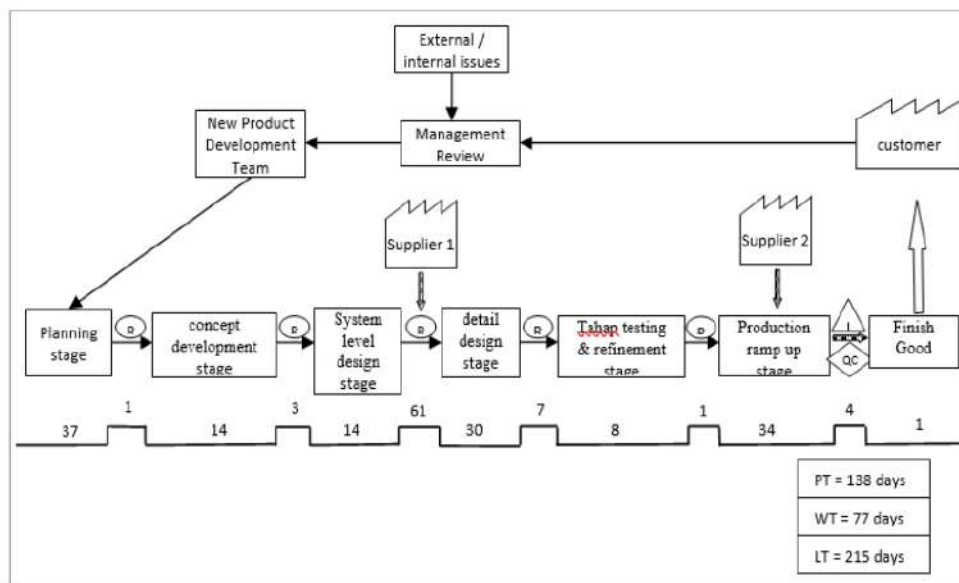

Figure 16. Future state of new product development with lean concept

Process improvement at each stage is illustrated by VSM as shown in figure 16. In the future VSM the largest NVA state is in the process of procuring machines, because machines must be imported. Information is still flowing manually from each stage. The organization has not implemented an information system that can be accessed quickly by the development team. Information system development needs to be considered for the process going forward. And the reduction time can considering the ergonomic aspect with analysing the human movement by any ergonomic tools like NIOSH

[16]. Stages of product development can be divided into two major stages namely the development design stage and the production stage [17]). The design and development phase starts from the planning stage to the testing and repair phase. At this stage there is no production process and the products are produced. While the production phase starts from the initial planned production. Table 14 shows that in both the design and development and production stages, the time can be shortened from 212 days to 176 days. The production phase can be accelerated from 50 days to 39 days. 3 Key factors in

Cite this Article As Muharom et al. (2019). Application Of New Product Development Value Stream Mapping: Case Study On Wire Steel And Nails Industry. *Journal of Engineering and Management in Industrial System*, 7(2), p53-68
Paper Accepted : November 28, 2019
Paper Published : November 30, 2019

developing new products is Time to Market (TTM). TTM is the time needed from planning to the new product being marketed. By applying lean to the product development process, the waste that was not seen will be easily identified with VSM, so that corrective actions can be taken to eliminate it. Then the time needed from the initial idea until the product is launched (TTM) will be reduced.

Figure 18 shows the product that is produced after the application of lean in product development. Before lean applied, TTM takes 262 days and after the repair of the TTM can be accelerated into 215 days. The results of this research show that the application of lean can reduce the TTM of 18%.

5. Conclusion

The results of this study show the experience of applying VSM to the development of new products in a wire and nail industry. VSM that

has been made at each stage of product development can help organizations to find out the value added and non value added. So the organization can make improvements to existing processes. Finally, the application of product development value stream mapping (PDVSM) can identify a VA value (value added) of 53% and NVA (non value added) 47%. Product development is carried out there is the potential to shorten time to market by 18% or 47 days. From the initial 262 days to 215 days.

Limitations of this study can be found in the number of employees who were respondents in the survey that was conducted. The time calculation focuses on the lead time of each activity. This PDVSM implementation research needs to be done on companies that have a larger number of employees and departments and are experienced in developing new products so that more representative research results will be obtained.

Table 5. Total lead time design & products and development

	<i>current</i>		<i>future</i>	
	day	%	day	%
Design and development	212	81%	176	82%
Production	50	19%	39	18%
Total (lead time)	262		215	

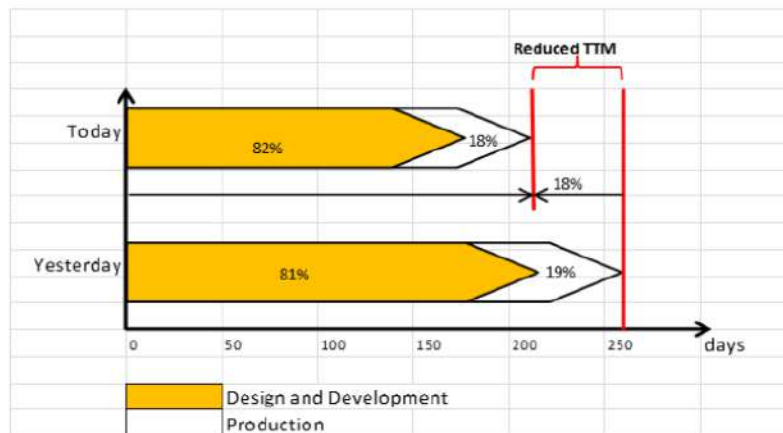

Figure 17. Time to Market Reached

References

- [1] Ulrich, K. T., & Eppinger S. D. (2001). *Product Design and Development*. McGraw-Hill, New York.
- [2] Lukodono, R., Pratikto, P., & Soenoko, R. (2013). Analisis Penerapan Metode RCM Dan MVSM Untuk Meningkatkan Keandalan Pada Sistem Maintenance (Studi Kasus PG. X). *Rekayasa Mesin*, 4(1), pp.43-52. Retrieved from <https://rekayasamesin.ub.ac.id/index.php/rm/article/view/177>
- [3] OECD. (2005). *Oslo Manual*. 3rd Edition.
- [4] Polder, M., Leeuwen, G. V., Mohnen, P., & Raymond, W. (2010). Product, process and organizational innovation: drivers, complementary and productivity effect. MPRA paper No. 23719.
- [5] Beyene, K. T., Shi, C. S., and Wu, W.W. (2016). The Impact of Innovation Strategy on Organizational Learning and Innovation Performance: Do Firm Size and Ownership Type make A Difference?. *South African journal of Industrial Engineering*. Vol 27 (1), page 125-136.
- [6] Chandra, G. C., and Haryadi, B. (2016). Proses Inovasi pada PT. Mekar Usaha Nasional. *AGORA* vol. 4, No. 2.
- [7] Batubara, S., and Kudsiah, F. (2011). Penerapan Konsep Lean Manufacturing untuk Meningkatkan Kapasitas Produksi. *Jurnal Teknk Industri*, ISSN:1411-6340.
- [8] Ohno, T. (1988). *Toyota Production System*. Productivity Press, page 8. ISBN 0-915299.
- [9] Andrianto, W., and Kholil, M. (2015). Analisis Penerapan Lean Production Process untuk Mengurangi Lead Time Process Perawatan Engine. *Jurnal Optimasi Sistem Industri*, Vol. 14 No.2.
- [10] Fanani, Z., & Singih, M. L. (2011). Implementasi lean manufacturing untuk peningkatan produktifitas. *Prosiding Seminar Nasional manajemen Teknologi XIII*.
- [11] Suci, E., Apreutesei, M. & Arvinte I.R. (2011). Value stream mapping-A lean production methodology. *The Annals of The "Ștefan cel Mare" University of Suceava. Fascicle of The Faculty of Economics and Public Administration* Vol. 11, No. 1(13). 184-196.
- [12] Kovac, M. (2013). *The Integration of Lean Management and innovation*. *Transfer inovaci* 26 / 2013.
- [13] Mascitelli, R. (2004). *The lean design guidebook: everything your product development team needs to slash manufacturing cost*. Northridge. *Technology Perspective*.
- [14] McManus, L.H., Millard, L.R. (2002). Value stream analysis and mapping for product development. *Proceedings of the International Council of the Aeronautical Sciences 23rd ICAS Congress*, 8-13 September, 2002, Toronto Canada
- [15] Lukodono, R., & Ulfa, S. (2018). Determination Of Standard Time In Packaging Processing Using Stopwatch Time Study To Find Output Standard. *Journal of Engineering and Management in Industrial System*, 5(2), p87-94. doi:<http://dx.doi.org/10.21776/ub.jemis.2017.005.02.5>
- [16] Setyanto NW, Efranto RY, Lukodono RP, Dirawidya A. Ergonomics analysis in the scarfing process by OWAS, NIOSH and Nordic Body Map's method at slab steel plant's division. *IJRSET* 2015; 4(3): 1086-93.
- [17] McManus, L.H. (2005). *Product Development Value Stream Mapping (PDVSM) Manual*. The Lean Aerospace Initiative.

LEAN MANUFACTURING IMPLEMENTATION FOR NEW PRODUCT DEVELOPMENT EFFECTIVENESS: CASE STUDY ON THE INDUSTRY OF WIRE STEEL AND DERIVATIVES

ORIGINALITY REPORT

5%

SIMILARITY INDEX

4%

INTERNET SOURCES

3%

PUBLICATIONS

5%

STUDENT PAPERS

PRIMARY SOURCES

1

Submitted to CSU, San Jose State University

Student Paper

5%

Exclude quotes On

Exclude matches < 3%

Exclude bibliography On